

CDC-0252-0600-1-ACB drive



5014068.16004

Find out about permission details from your D+H Partner

Performance features

- » Perfectly suited for profile integrated and surface mounted installation
- » Low running noises thanks to the innovative acoustic decoupling of the drive components
- » Universal bracket sets for installation of all commonly available profile systems
- » Flexible overall lengths for customised strokes
- » Available in all RAL colours
- » Can be used for virtually all window opening types thanks to the left and right drive
- » Integrated ACB (Advanced Communication Bus) bus interface with Modbus protocol
- » The drive is integrated directly via open bus communication through the ACB (Advanced Communication Bus), e.g. in a building management system

Potential drive options



You can find the explanations for the icons on the last page

Pressure load diagram

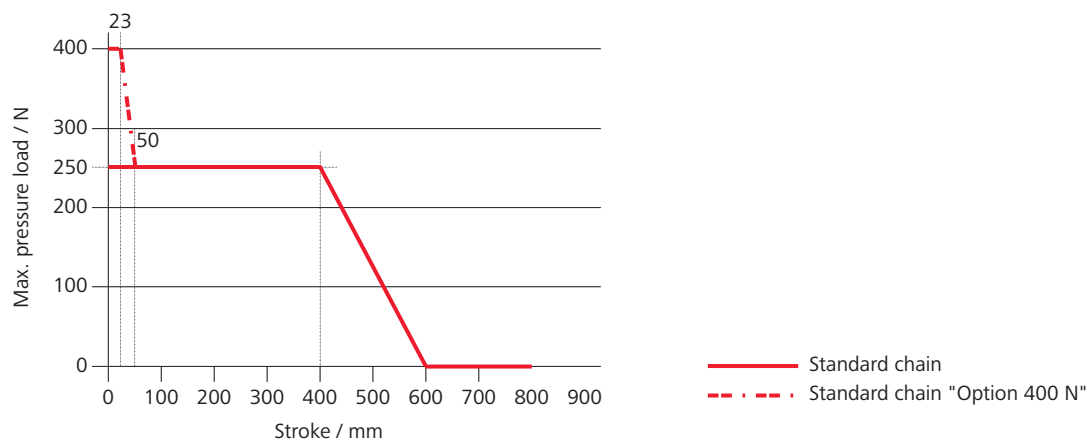

Technical data

Supply	24 V DC / $\pm 15\%$ / 0.8 A
Force of pressure	250 N
Tensile force	250 N
Nominal locking force	1500 N
Service life	> 10000 double strokes
OPEN running speed	6.7 mm/s
OPEN running speed - SHEV	13.6 mm/s
CLOSED running speed	6.7 mm/s
Type of protection	IP 32
Emission sound pressure level	LpA = 35 dB(A)
Temperature range	-5 °C ... +75 °C
Housing	Aluminium
Surface	Powder-coated
Colour	White aluminium (~ RAL 9006)
Connection	2.5 m silicone cable
W x H x D	530 x 30 x 35 mm
Weight	1.31 kg

Dimensions

All specifications in mm

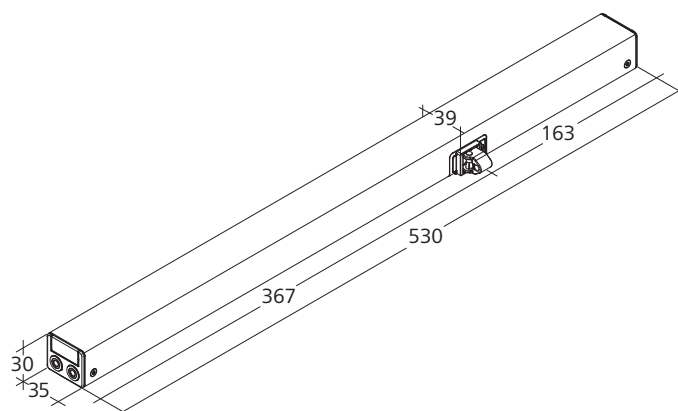

Design

Type	Art. No.	Stroke	Remark
CDC-0252-0600-1-ACB M1-R	26.101.05	600 mm	Right type
CDC-0252-0600-1-ACB M1-L	26.101.10	600 mm	Left type
CDC-0252-0600-1-ACB M2-R	26.101.06	600 mm	Right type
CDC-0252-0600-1-ACB S1-L	26.101.11	600 mm	Left type
CDC-1-ACB	26.100.00		Variable equipment possible

Brackets are not included and have to be ordered separately.



HS "High-Speed"

In the case of SHEV, the high-speed function is used for reliably reaching the defined end position in 60 s. In daily ventilation mode, the drive runs quietly and quickly, as usual.



Function programming

Option for customised configuring of drive parameters (e.g. stroke) via software and associated service tools for drives equipped with PLP, BSY or BSY+ electronics.



BRV signal

Acknowledgement from the drive, via a control cable, to confirm that it has been completely extended or retracted. When used with the AT 41 and ERM 44 modules, this signal is sent to the central building control system, the modules themselves, or to the lock drive. The BRV signal is not isolated.



ACB (Advanced Communication Bus)

Enables direct bus communication between the controller and the drive for, for example, control with perfect positioning or drive feedback. Communication is via the open source Modbus protocol, and it enables the drive to be combined with an ACB-capable control panel or enables it to be directly connected to higher-level controllers such as a building management system.



BSY+ (synchronisation of drives)

In addition to providing the same synchronisation function as BSY, BSY+ enables different components in the window to communicate with each other. For example, the chain drives, during synchronous operation, or the window and lock drives (e.g. FRA 11 BSY+ or VLD-BSY+).



SGI signal (position reporting)

In combination with the D+H servo plug-in unit SE 622, the drives can be controlled with perfect positioning.



SKS (closing edge protection)

Drive option, which enables an anti-trap strip or presence detector to be connected directly to the drive (terminal resistor 5.6 kΩ).



Audible signal (corresponding to protection class)

AS2 corresponding to "Protection class 2" in accordance with ZVEI risk assessment through an audible warning signal in the "CLOSED" running direction. AS3 corresponding to "Protection class 3" in accordance with ZVEI risk assessment, in addition to AS2, stops the drive for 11 s with a remaining stroke of 28 mm.



End position message (OPEN / CLOSED)

Drive feedback via an integrated isolated switching contact. This happens if the chain / rack and pinion has moved completely out or in.



Mechanical adjustment

Drive option for adjusting the overall length or design (e.g.: centred chain outlet).



SBD side bow chain

Drive chain with rigid backing, bends in the direction of the hinge. Drive is fixed in place (not rotatable).



SBU side bow chain

Drive chain with rigid backing, bends in the direction of the hinge. Drive is fixed in place (not rotatable).